

JUNG PUMPEN U6K SUBMERSIBLE DRAINAGE PUMPS

APPLICATION

The U6K range of pumps is suitable for stationary and portable use.

It can be used as a drainage pump for mildly contaminated waste and ground water, in sumps with rain water, drainage or seepage water, silage liquor and also liquid manure. The high quality mechanical seal also makes the pump suitable for extracting abrasive media.

In stationary use the U6K ES/DS removes the waste water from domestic appliances such as dishwashers and washing machines (also high temperature). The guide rail system GR 32 offers all the advantages of fast and easy maintenance. Our ready-to-install collecting tanks extend the options for installation and use.

For supporting sewage water with heavy pollution we recommend our US series. Especially for the transportable use, in building site areas for example, our building pumps UB should be used.

If centrifugal submersible pumps are used outdoors, only a pump with 10 m cable without extension cable may be used in accordance with VDE Regulation 0100.

- Continuous operation
- Flushing device
- Replaceable moisture sealed cable inlet
- Low level pumping by removing the strainer base
- SiC mechanical seal independent of rotation direction
- Safe to run dry
- 10/20 mm free passage with EIP technology



U 6 K with built-in level control

PERFORMANCE

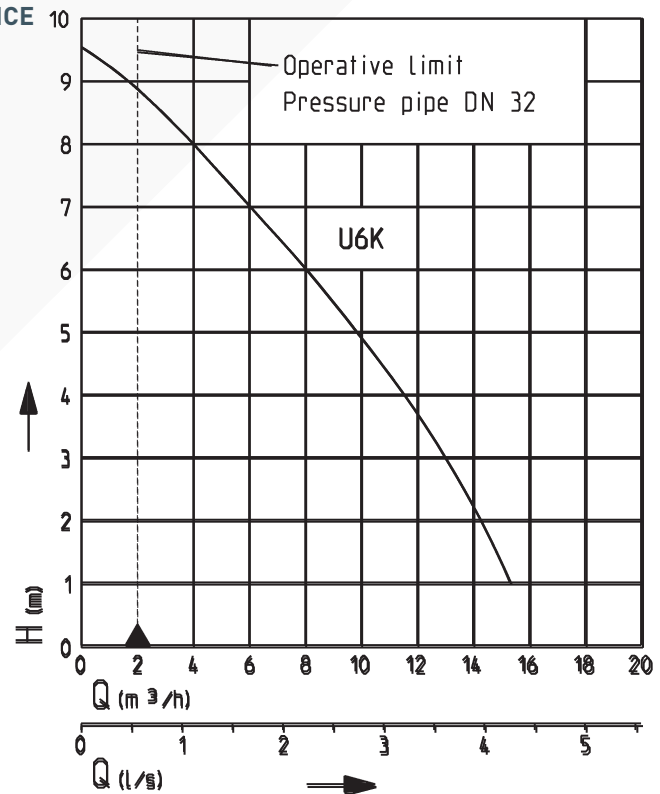

42527-00

We reserve the right to change specifications without notice

Pump performance is subject to ISO 9906 tolerances

The minimum flow velocity in the pressure piping must be 0.7 m/s according to EN 12056.

This data is represented in the performance curve as a limit of application.

JUNG PUMPEN U6K

SUBMERSIBLE DRAINAGE PUMPS

SUBMERSIBLE DRAINAGE PUMPS

Type	Maximum Height x Width	Discharge branch	Free passage	Cable quality H07RN-F-	Cable length	Weight approx.	Code No.
Pumps without level control							
U6K E	335 x 175 mm	1 1/4"	20 mm	3G1,0	10 m	6,0 kg	JP00226
U6K D	335 x 175 mm	1 1/4"	20 mm	4G1,0	10 m	6,5 kg	JP00228
Pumps with built-in level control (acc. to VDE, only to be used outdoors with 10 m cable)							
U6K ES	335 x 210 mm	1 1/4"	20 mm	3G1,0	3 m	5,5 kg	JP00227
U6K DS	335 x 210 mm	1 1/4"	20 mm	4G1,0	3 m	5,9 kg	JP00229
U6K ES	335 x 210 mm	1 1/4"	20 mm	3G1,0	10 m	6,2 kg	JP09260
U6K DS	335 x 210 mm	1 1/4"	20 mm	4G1,0	10 m	6,8 kg	JP09261

PERFORMANCE

Type	Delivery head H [m]	1	2	3	4	5	6	7	8	9
U6K E/ES/D/DS	Flow rate Q [m³/h]	15.5	14.5	13.0	11.5	9.5	8.0	6.0	4.0	1.5

ELECTRICAL DATA

Type	Type of current	Voltage Volt	Motor rating kW		RPM min ⁻¹	Current Ampere	Motor protection	Plug
			P ₁	P ₂				
U6K E/ES	W-Strom	1/N/PE-230	0.75	0.49	2645	3.3	integriert	Safety-
U6K D/DS	D-Strom	3/PE-400	0.75	0.55	2678	1.3		CEE-

Example of single pump installation with GR

Single unit with built-in level control
 Sump area **with GR 32** min. 40 x 50 cm
 Sump area **without GR** min. 40 x 40 cm (without illustr.)

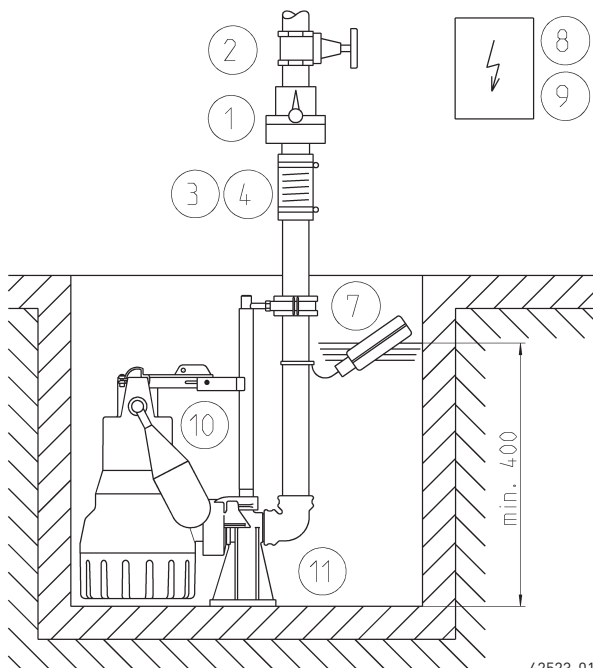

In case of installation beneath the backpressure level the pressure tube must be taken in a loop over the local backup level acc. to EN 12056. Besides, it must be secured with an EN 12050-4-proofed swing-type check valve. Besides, it must be secured with an EN 12050-4-proofed swing-type check valve. Additionally we recommend an alarm system.

Example of duplex pump installation

Duplex unit with control unit
 Sump area **with GR** min. 50 x 50 cm (without illustration)
 Sump area **without GR** min. 50 x 50 cm
 Suspend control unit in a dry room.

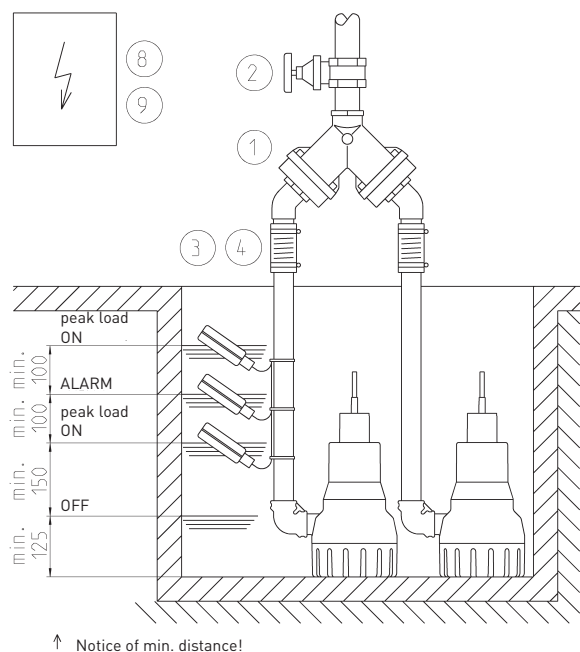









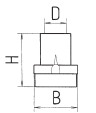

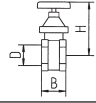

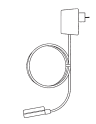
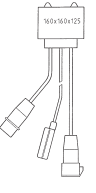
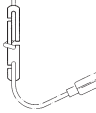

In accordance with DIN EN 12056-4 section 5.1, it has a built-in automatic spare pump or a double attachment included, which ensures that sewage drainage is not interrupted.

JUNG PUMPEN U6K

SUBMERSIBLE DRAINAGE PUMPS

ACCESSORIES

		Code No.	U6K E	U6K D	U6K ES	U6K DS
	1 Swing-type check valve 1¼" (DN 32), PN 4 DIN EN 12050-4 H W D 90 90 1¼"	JP09739	•	•	•	•
	Duplex swing-type check valve ½" (DN 40), PN 4 for duplex pump station, DIN EN 12050-4 H W D 200 280 ½"	JP09155	•	•		
	2 Stop valve ¼" (DN 32), PN 16 H W D 110 max. 60 ¼"	JP44785	•	•	•	•
	½" (DN 40), PN 16 125 max. 60 ½"	JP44786	•	•		
	3 Elastic connection ¼" (DN 32), PN 3 H D 100 42	JP44773	•	•	•	•
	4 Hose band clamp ¼"	JP44765	•	•	•	•
	5 Hose coupling ¼" (DN 32) brass, for portable use	JP00327	•	•	•	•
	Solid fire hose coupling 1 ¼" male thread	JP44780	•	•	•	•
	Coupling wrench	JP25708	•	•	•	•
	Hose connection 1 ¼" - 38/32/25	JP44209	•	•	•	•
	6 Hose set, 15 m PVC hose c/w elbow	JP43550	•	•	•	•
	7 Alarm unit AG3 with submersible ball contact switch, separate, mains-dependent, with potential-free contact and 3 m cable	JP44891			•	•
	Alarm unit AG10 with sub. ball contact switch ,ditto, 9.5 m cable	JP44892			•	•
	Alarm unit washing machine stop AW3 with submersible ball contact switch with 3 m cable, separate, mains-dependent	JP44895	•	•	•	•
	8 Separate level controls for single unit (see level controls for description)					
	NE 1 (1-phase) with sub. ball contact switch 3.0 m	JP16710	•			
	NE 2 (1-phase) with sub. ball contact switch 9.5 m	JP16711	•			
	ND 1 (3-phase) with sub. ball contact switch 3.0 m	JP16712		•		
	ND 3 (3-phase) with sub. ball contact switch 9.5 m	JP16713		•		
	NE 1A (1-phase) with sub. ball contact switch 3.0 m and alarm	JP16714	•			
	NE 2A (1-phase) with sub. ball contact switch 9.5 m and alarm	JP16715	•			
	ND 1A (3-phase) with sub. ball contact switch 3.0 m and alarm	JP16716		•		
	ND 3A (3-phase) with sub. ball contact switch 9.5 m and alarm	JP16717		•		
	Counterweight (1 piece)	JP44803	•	•		
	Controls for duplex unit (see section on Level controls for description)					
	BD 00E (1-phase)	JP45735	•			
	BD 00 (3-phase)	JP45993		•		
	Subm. switch pack B with 3 subm. ball contact switches with 9.5 m cable and fixing device	JP16725	•	•		
	Subm. switch pack BmG with 3 subm. ball contact switches with 9.5 m cable and counterweight	JP16726	•	•		
	9 Rechargeable battery for off the line operation of the alarm	JP44850	•	•	•	•
	10 Special float assembly for low switching points (Switching height without GR ON 130 mm, OFF 80 mm)	JP44207			•	•
	Special float assembly for narrow chambers (min. 30 x 30 cm)	JP40856			•	•
	Special float assembly for continuous pump operation	JP42175			•	•
	11 Guide rail system GR 32	JP44000	•	•	•	•
	Support for guide rail extension ex 2 m sump depth, per m 1 peace	JP28314	•	•	•	•

JUNG PUMPEN U6K

SUBMERSIBLE DRAINAGE PUMPS

TECHNICAL DATA

Pump

Vertical, single-stage, submersible, with foot strainer with 10 mm free passage – detachable for activating low level pumping. With the pump base installed, free passage is 20 mm. Volute casing with 1 1/4" male radial pressure branch, EIP-technology hydraulics with open 6-blade impeller.

Bearings

Common shaft for pump and motor, mounted in ball bearings and permanently grease lubricated.

Seal

Silicon carbide mechanical seal, intermediate oil chamber, shaft seal ring towards the motor section, safe to run dry.

Motor

Submersible motor, type of enclosure IP 68, insulation class B, motor thermostat for emergency switch-off on overheating with automatic switch-on after sufficient cooling, switched on via plug or automatic switching, moisture sealed cable inlet for protecting the pump in the event of damage to the cable, continuous operation when not submerged on account of its motor jacket cooling.

Material

Motor housing, shaft and screws in stainless steel, volute casing, impeller and control head in plastic (GRP), rubber insulated flexible cable.

Installation

Install pump vertically (hose connection possible); if installed permanently, provide detachable connection, e.g. the uncomplicated and easy to maintain guide rail system GR 32.

Scope of supply

Pump ready for connection acc. to EN 12050 with 90°, 1 1/4" female connection elbow, cable and plug, S model with automatic level float switch.

The pump is delivered fitted with a strainer base which can be swapped for any of the accompanying pedestals in cases where a 20 mm clear passage is required.



Dimensions U6K (mm)

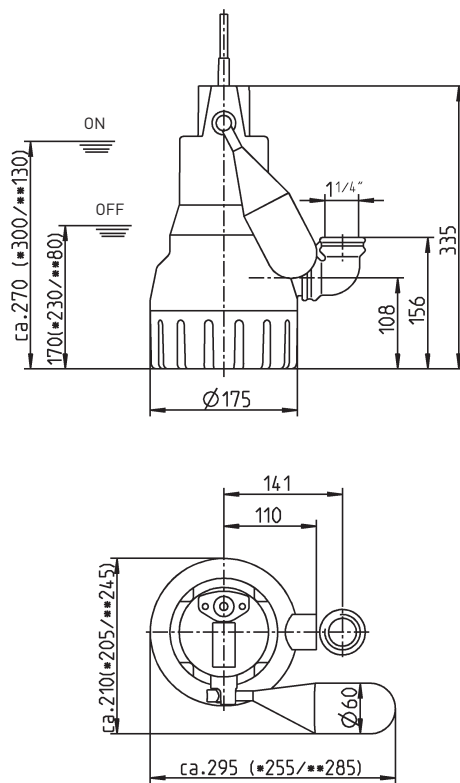

* with low level float Code. No. JP40856
** with low level float Code. No. JP44207

4 42525-02

Dimensions GR 32 (mm)

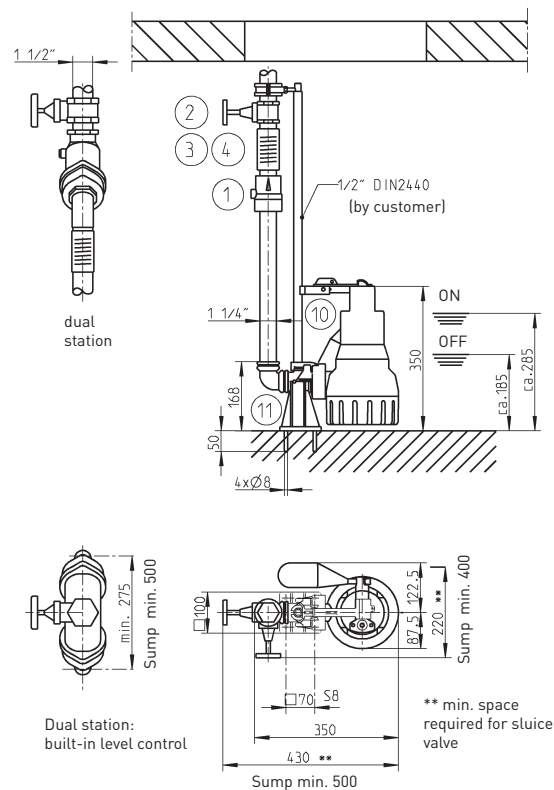

** min. space required for sluice valve

4 42526-02