

JUNG PUMPEN MULTICUT SEWAGE PUMPS

APPLICATION

Centrifugal submersible sewage pumps fitted with the MultiCut cutting system are used as stationary appliances in pressurised drainage systems for discharge in sparsely populated areas or of detached houses. They are suitable for pumping domestic wastewater with the usual additions (as specified in German standard DIN 1986, Part 3).

For pumping from ducts which are connected to the public sewer system, explosion-proof submersible pumps have to be used. On account of the upstream cutting system, the pressurised line as from DN 32 - as from DN 80 minimum without cutting system - may be routed parallel to the terrain.

Operating conditions up to a temperature of the material to be transported of 40° Celsius

Submerged motor:
Continuous operation (S1)
Emerged motor:
Intermittent operation (S3)
(e.g. 20% = 2 min. operation,
8 min. break)

MULTICUT CUTTING SYSTEM

The unique MultiCut cutting system ensures a maximum of operational safety at outstanding delivery characteristics. Fitted with a cutter plate made of hardened stainless steel and a three-bladed knife, it disintegrates coarse additions in the wastewater with more than 62,000 cutting processes per minute before they can get into the pump hydraulics. Solids which cannot be transported are rejected outside of the pump by the cutting rotor as the cutting system is located upstream from the pump hydraulics. Specifically arranged grooves on the cutter plate ensure additional safety as the cutting unit is permanently cleaned automatically during the delivery.

- Cutting rotor with stirring effect
- Plug-in cable connection
- External adjustable cutting mechanism
- Controllable oil chamber
- SiC mechanical seal independent of sense of rotation
- Moisture-sealed cable inlet
- Installed motor protection



- **NEW:** MultiCut 20/2 M plus
 - 10% less energy consumption
 - 20% less weight as 25/2 M
 - Impeller and replaceable wear plate made from Grivory (fibre-glass reinforced plastic)

PERFORMANCE

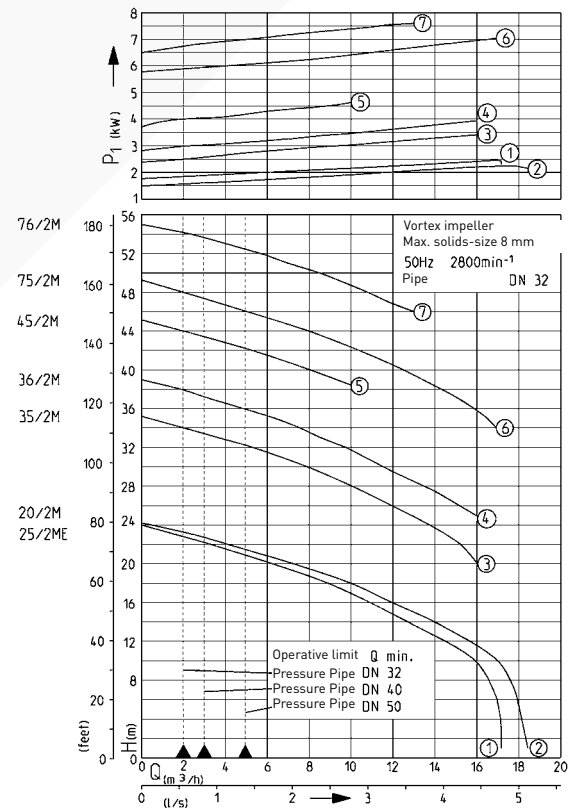

We reserve the right to change specifications without notice Pump performance is subject to ISO 9906 tolerances
The minimum flow velocity in the pressure piping must be 0.7 m/s according to EN 12056.
This data is represented in the performance curve as a limit of application.

JUNG PUMPEN MULTICUT SEWAGE PUMPS

Mounting arrangement with ball check valve

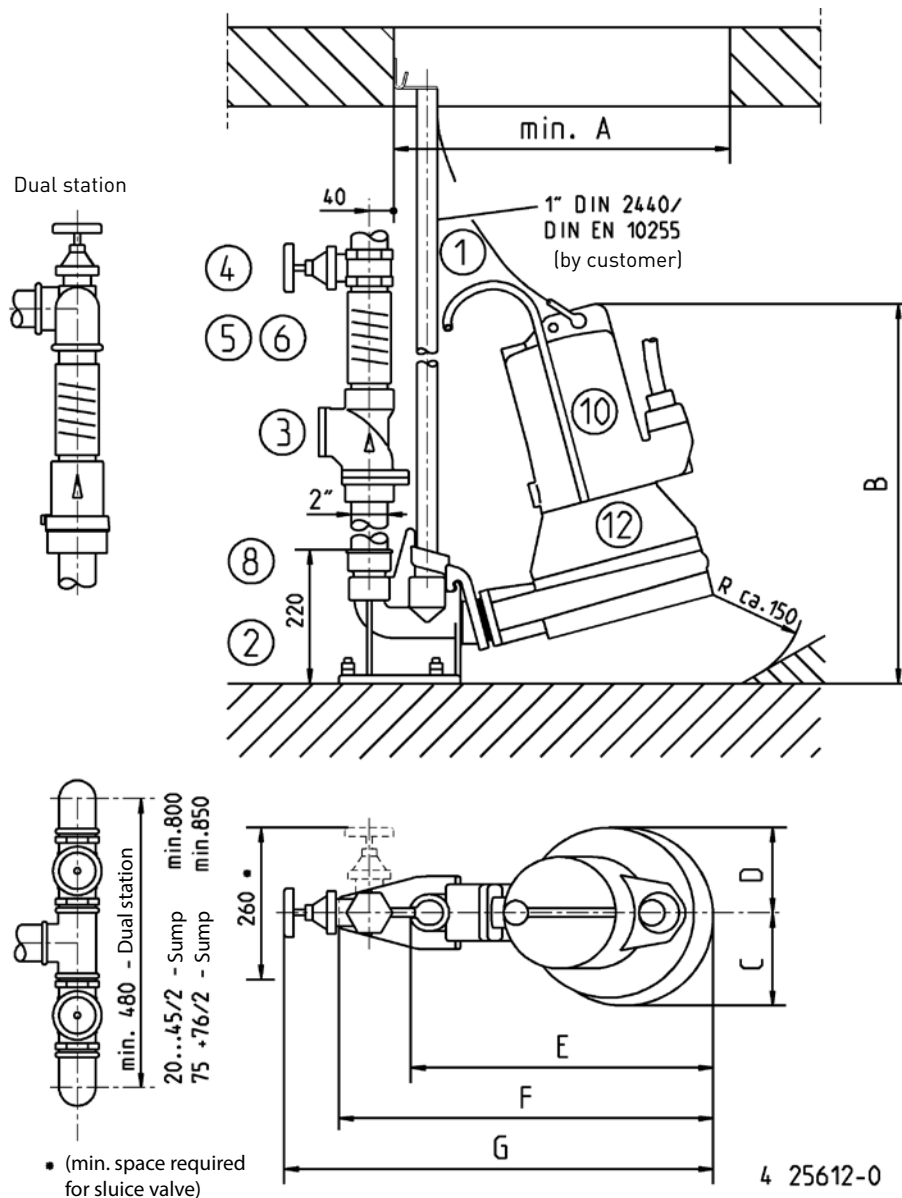









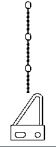

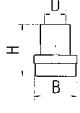
	A	B	C	D	E	F	G	Sump dimation min.
20/2M plus	430	450	110	110	380	500	585	400 x 700mm
25/2ME-36/2M	470	490	125	125	420	540	635	400 x 700mm
45/2M	470	490	130	125	420	540	635	400 x 700mm
75/2M+76/2M	545	625	155	140	500	615	705	400 x 800mm

JUNG PUMPEN MULTICUT

SEWAGE PUMPS

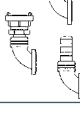
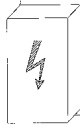
ACCESSORIES

		Code No.	20/2 M plus	25/2 ME	35/2 M	36/2 M	45/2 M	75/2 M	76/2 M
	1 Chain , certified, stainless steel, (EN 818 mod.)	Load-bearing cap.							
	2,5 m, 5 rings	160 kg	•	•	•	•	•	•	•
	5,0 m, 8 rings	160 kg	•	•	•	•	•	•	•
	Shackle , certified, stainless steel	500 kg	•	•	•	•	•	•	•
	Pump hanging	JP45925	•	•	•	•	•	•	•
	2 Guide rail system GR 35 , 1½" Female thread (see mounting arrangem.)	JP14094	•	•	•	•	•	•	•
	Shift of centre of gravity	JP44757						•	•
	3 Swing-type check valve 1½" (DN 40), PN 4	H B D 150 120 1½"	•	•	•	•			
	DIN EN 12050-4	2" (DN 50), PN 4	150 120 2"	•	•	•			
	Ball check valve 2" (DN 50), PN 6	185 155 2"	•	•	•	•	•	•	•
	DIN EN 12050-4 (no illustr.)	Elbow ball check valve KE 1½" (DN 40), PN 6	170 125 1½"	•	•	•	•	•	•
DIN EN 12050-4									
	4 Stop-off valve 1½" (DN 40), PN 16	H B D 125 max.60 1½"	•	•	•	•	•	•	•
	2" (DN 50), PN 16	140 max.67 2"	•	•	•	•	•	•	•
	5 Elastic connection 1½" (DN 40), PN 4	H D inside 120 50	•	•	•	•			
	2" (DN 50), PN 4	150 63	•	•	•	•			
	6 Clamp 1½"	JP44763	•	•	•	•			
	2"	JP44764	•	•	•	•			
	7 Pump base	JP44759	•						
	Pump base M (without illustration)	JP20980		•	•	•	•		
	Pump base M 220	JP22302						•	•
	8 Reducing socket 1½"–2" for Guide rail system GR 35	JP44776	•	•	•	•	•	•	•
	1¼"–1½" for pipe connection	JP44769	•	•	•	•	•	•	•
	1½"–2" for pipe connection	JP44772	•	•	•	•	•	•	•
	9 Pipe connection 1¼" (inside thread), for transportable application	JP16870	•	•	•	•	•	•	•
	Coupling connection size C, for transportable application	JP14076	•	•	•	•	•	•	•
	Hose connection Ø 42, for transportable application	JP14077	•	•	•	•	•		
10 Flushing tube Type 0		JP45408	•						
	Flushing tube Type I	JP28221		•	•	•	•		
	Flushing tube Type II	JP28222						•	•
	11 Electrical connection								
	Single unit	AD 12 ExME, DRP	JP43163	•					
	+ soft starting device		JP24138	•					
	AD 46 ExM, DRP		JP43160	•					
	AD 46 MP SM*		JP27119	•					
	AD 610 ExM, DRP		JP43161			•	•	•	
	AD 610 MP SM*		JP27120			•	•	•	
	AS 610 ExM, DRP		JP43164						•
	Duplex unit	BD 46 ExM, DRP	JP43166	•					
	BD 46 MP SM*		JP27153	•					
	BD 610 ExM, DRP		JP43167			•	•	•	
BD 610 MP SM*		JP27154			•	•	•		
BS 610 with accessories - see controls								•	
All control units above incl. static air level controls (except BS 610)									
Accessories for AD ... / BD ... Retaining plate (scope of supply of GR 35)		JP23100	•	•	•	•	•	•	•
* Control panels for pumps in explosive hazardous locations require a dry run protection		JP41463							
	Rechargeable battery for mains-independent alarm (for MP SM control order article No. JP 28603)	JP44850	•	•	•	•	•	•	•
	12 Seal leak detectorDKG	JP44900		•	•	•	•	•	•
	Seal leak detectorDKG-Ex (pumps with Ex-proof)	JP00249	•	•	•	•	•	•	•

JUNG PUMPEN MULTICUT

SEWAGE PUMPS

SEWAGE PUMPS

Type without ex-proof	Code No.	Type with ex-proof	Code No.	Largest height x width	Cable length	Pressure connection	Weight approx.
20/2 M plus	JP42765	20/2 M plus, Ex	JP42766	350 x 290 mm	10 m	DN 32	29,0 kg
25/2 ME*	JP09843	25/2 ME*, Ex	JP09742	390 x 330 mm	10 m	DN 32	38.0 kg
35/2 M	JP09806	35/2 M, Ex	JP09807	390 x 330 mm	10 m	DN 32	40.5 kg
36/2 M	JP09907	36/2 M, Ex	JP09908	390 x 330 mm	10 m	DN 32	40.5 kg
45/2 M	JP09430	45/2 M, Ex	JP09431	390 x 330 mm	10 m	DN 32	42.0 kg
75/2 M	JP09912	75/2 M, Ex	JP09913	520 x 430 mm	10 m	DN 32	90.0 kg
76/2 M	JP09262	76/2 M, Ex	JP09263	520 x 430 mm	10 m	DN 32	90.0 kg

* See special technical notes in the chapter on "Technical data".

PERFORMANCE

Type	Delivery head H [m]	6	9	12	15	18	21	25	28	32	34	36	38	40	44	46	48	50	52	54
20/2 M plus	Flow rate Q [m³/h]	18	17	16	13	10	6													
25/2 ME		17	16	15	12	9	5													
35/2 M							16	13	10	5										
36/2 M								16	14	10	7	5	2							
45/2 M													10	8	2					
75/2 M											17	16	15	13	8	5	2			
76/2 M																13	11	9	6	3

ELECTRICAL DATA

Type	Voltage	Motor rating kW		S3 %	Current Ampere	Built-in motor protection	RPM min. ⁻¹	Cable pluggable		Device Fuse min.
	Volt	P ₁	P ₂							
20/2 M plus	3/PE~230/400	2.40	1.91	25	7.0/4.0	Thermostat		H07 RN-F 6G 1.5	10 A	
25/2 ME**	1/N/PE~230	2.70	2.04	35	12.0	Thermostat	2860	H07 RN-F 6G 1.5	16 A	
35/2 M	3/PE~230/400	3.70	3.04	40	11.5/6.6	Thermostat	2895	H07 RN-F 6G 1.5	10 A	
36/2 M	3/PE~230/400	4.20	3.42	30	12.7/7.3	Thermostat	2880	H07 RN-F 6G 1.5	10 A	
45/2 M	3/PE~230/400	4.84	3.93	25	13.7/7.9	Thermostat	2857	H07 RN-F 6G 1.5	10 A	
75/2 M	3/PE~400/690	7.70	6.60	30	13.2/7.7	Thermostat	2920	H07 RN-F 10G 2.5	20 A***	
76/2 M	3/PE~400/690	7.70	6.60	30	13.2/7.7	Thermostat	2920	H07 RN-F 10G 2.5	20 A***	

** Operation possible only with control AD 12 ExME !

*** Value for Y/Δstart

JUNG PUMPEN MULTICUT

SEWAGE PUMPS

TECHNICAL DATA

Pump

Vertical, single-stage, submersible, pump housing with horizontal discharge, open impeller with external cutting system MultiCut - adjustable.

Bearings

Common shaft for pump and motor, grease-packed ball bearing.

Seal

Silicon-carbide mechanical seal independent of the sense of rotation, oil chamber and artificial carbon mechanical seal or duplex rotary shaft seal to motor compartment, safe to run dry.

Motor

Submersible, insulation class F, type of protection IP 68, protected by winding thermostats, automatic activation by control only or - up to 3.2 kW three-phase current - by CEE plug with motor protection upon request, ex-proof types tested by German PTB Federal Agency, ex-proof Type PTB-certified, ex designation $\text{Ex II 2 G Ex d IIB T4 [20/2 M plus, Ex II 2 G Ex d IIB T4 Gb]}$

Materials

Pump and motor housing as well as impeller made of grey cast iron GG (impeller 75/2 and 76/2 made of spheroidal graphite iron), MultiCut 20/2 M plus impeller and replaceable wearplate made from fibreglass reinforced plastic, completely covered shaft with no contact to the pumped liquid, stainless steel hardened (57 HRC) cutting system, special flexible rubber cable.

Scope of supply

Sewage pump with or without explosion-proof in keeping with German / European standard DIN EN 12050 with shackle and 10 m cable, without plug, without base.

Special technical note for 25/2 ME

As the rated output of the motor exceeds 1.4 kW, the permission of the local power supply organisation has to be obtained prior to ordering and commissioning.

SOFT STARTING DEVICE (ONLY FOR 25/2 ME)

The soft starting device is a resistance starter with a built-in overheating protection in order to reduce the starting current to approx. 33 A. The maximum switching frequency is 10/switching action per hour (at an ambient temperature of 40° Celsius).

This assembly group is installed in the AD 12 ExME control in the factory when ordered. A subsequent installation is not possible.



Dimensions with pump base (mm)

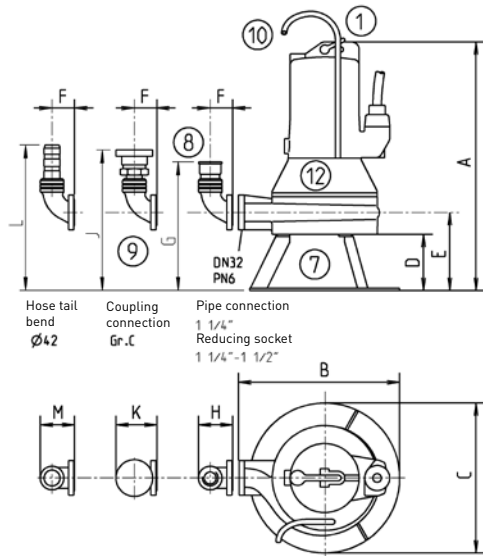

Typ	A	B	C	D	E	F	G	H	J	K	L	M
20/2M	440	290	230	100	140	60	230	90	310	110	320	90
25/2ME	520	330	250	140	180	60	270	90	350	110	360	90
35/2M+36/2M	520	330	250	140	180	60	270	90	350	110	360	90
45/2M	520	330	255	140	180	60	270	90	350	110	360	90
75/2M+76/2M	665	430	400	150	210	60	300	90	380	110	-	-

22625-08

FLUSHING TUBE

The flushing tube is screwed into the annular casing of the pump instead of the venting screw. It vents the pump and at the same time cleans the chamber with a jet of water. This bypass causes a loss of performance of abt. 10%.

Some pumps require a minimum head to ensure a sufficient flushing effect (see table):

Pump type	Installation	Minimum head Hman [m]
... 20/2 M plus	straight	15
... 20/2 M plus	inclined	4
... 25/2 ME	straight	15
... 25/2 ME	inclined	4
... 35/2 M	straight	25
... 35/2 M	inclined	12
... 36/2 M	straight	25
... 36/2 M	inclined	12
... 45/2 M	straight	30
... 45/2 M	inclined	30

JUNG PUMPEN MULTICUT SEWAGE PUMPS

Mounting arrangement with PKS sump

