

JUNG PUMPEN COMPLI 1200-1600

SEWAGE LIFTING STATIONS - STAINLESS STEEL

APPLICATION

The sewage lifting stations compli 1200, 1400 and 1600 have been designed for use in multi-family houses and in industrial and communal areas with a large volume of wastewater, where special safety regulations have to be met, for example at underground stations, airports or parking decks.

The submersible unit is permitted for general use in areas subject to flooding. The control unit has to be fitted in a well ventilated flood-proof room.

The stainless steel tank has freely accessible drains and a clamp-type inlet flange for easy installation. The top-mounted cleaning opening and the easy replaceability of the pre-mounted pumps also ensure time-saving servicing.

The vortex impeller with 80 mm (BW-pumps) or 100 mm (CW-pumps) free passage ensures a high operating safety.

Duplex systems have two pump units on one tank which are switched alternately or, if and when required, they are operated both in order to cope with peak load or reserve operation. This automatic switching sequence increase safety in particular for use in commercial or public buildings, and is always required in keeping with German / European standard DIN EN 12056-4 para. 5.1, when the wastewater inflow must not be interrupted.

- Ready to plug in
- Submersible
- High-class stainless steel tank
- Large storage volume
- Large free passage



Duplex system compli 1200 - stainless steel

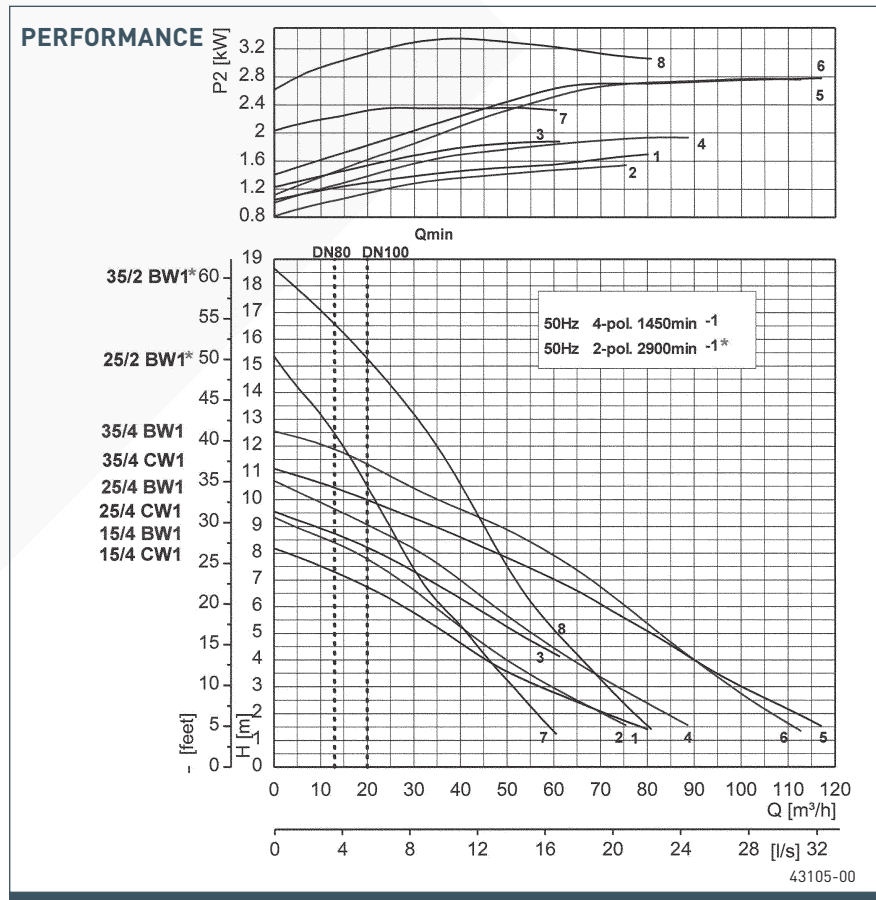

We reserve the right to change specifications without notice

Pump performance is subject to ISO 9906 tolerances

The minimum flow velocity in the pressure piping must be 0.7 m/s according to EN 12056. This data is represented in the performance curve as a limit of application.

JUNG PUMPEN COMPLI 1200-1600

SEWAGE LIFTING STATIONS - STAINLESS STEEL

SEWAGE LIFTING STATIONS

Type compli	Tank capacity l	Max. pump volume l	Inlet height mm	Free passage mm	Clamp-ty-pe inlet flange	Connec-ting flange PN 10	For connec-ting pipe	Venti-lation	Weight approx.	Code No.
1215/4 BW1	270	110	700	80	DN 150	DN 80	DN 100	DN 70	238 kg	JP42988
1225/4 BW1	270	110	700	80	DN 150	DN 80	DN 100	DN 70	238 kg	JP42989
1235/4 BW1	270	110	700	80	DN 150	DN 80	DN 100	DN 70	242 kg	JP42990
1225/2 BW1	270	110	700	80	DN 150	DN 80	DN 100	DN 70	237 kg	JP42991
1235/2 BW1	270	110	700	80	DN 150	DN 80	DN 100	DN 70	240 kg	JP42992
1215/4 CW1	270	110	700	100	DN 150	DN 100	DN 100	DN 70	242 kg	JP42985
1225/4 CW1	270	110	700	100	DN 150	DN 100	DN 100	DN 70	242 kg	JP42986
1235/4 CW1	270	110	700	100	DN 150	DN 100	DN 100	DN 70	246 kg	JP42987
1415/4 BW1	540	225	800	80	DN 150	DN 80	DN 100	DN 70	291 kg	JP42996
1425/4 BW1	540	225	800	80	DN 150	DN 80	DN 100	DN 70	291 kg	JP42997
1435/4 BW1	540	225	800	80	DN 150	DN 80	DN 100	DN 70	295 kg	JP42998
1425/2 BW1	540	225	800	80	DN 150	DN 80	DN 100	DN 70	290 kg	JP42999
1435/2 BW1	540	225	800	80	DN 150	DN 80	DN 100	DN 70	293 kg	JP43000
1415/4 CW1	540	225	800	100	DN 150	DN 100	DN 100	DN 70	295 kg	JP42993
1425/4 CW1	540	225	800	100	DN 150	DN 100	DN 100	DN 70	295 kg	JP42994
1435/4 CW1	540	225	800	100	DN 150	DN 100	DN 100	DN 70	299 kg	JP42995
1615/4 BW1	900	400	800	80	DN 150	DN 80	DN 100	DN 70	333 kg	JP43004
1625/4 BW1	900	400	800	80	DN 150	DN 80	DN 100	DN 70	333 kg	JP43005
1635/4 BW1	900	400	800	80	DN 150	DN 80	DN 100	DN 70	337 kg	JP43006
1625/2 BW1	900	400	800	80	DN 150	DN 80	DN 100	DN 70	332 kg	JP43007
1635/2 BW1	900	400	800	80	DN 150	DN 80	DN 100	DN 70	335 kg	JP43008
1615/4 CW1	900	400	800	100	DN 150	DN 100	DN 100	DN 70	337 kg	JP43001
1625/4 CW1	900	400	800	100	DN 150	DN 100	DN 100	DN 70	337 kg	JP43002
1635/4 CW1	900	400	800	100	DN 150	DN 100	DN 100	DN 70	341 kg	JP43003

PERFORMANCE

Type	Delivery head H [m]	1	2	3	4	5	6	7	8	9	10	12	14	16
compli ...15/4 BW1	Flow rate Q [m³/h]	80	70	60	50	42	35	27	18	5				
compli ...25/4 BW1		95	85	74	64	55	47	40	32	21	9			
compli ...35/4 BW1		115	107	98	90	82	75	68	59	49	35	10		
compli ...25/2 BW1		67	61	54	48	43	38	34	31	26	21	10		
compli ...35/2 BW1		80	74	68	64	58	52	48	45	42	38	31	20	10
compli ...15/4 CW1		87	71	57	46	37	28	17						
compli ...25/4 CW1					61	53	42	32	23					
compli ...35/4 CW1		122	112	100	90	81	71	60	48	35	20			





ELECTRICAL DATA

Type	Type of current	Voltage Volt	Motor rating kW		Current Ampere	RPM min ⁻¹	Cable (10 m) Tank control	Cabel (1.5 m) Control plug	Plug
			P ₁	P ₂					
compli ...15/4 BW1	D-Strom	3/N/PEp400	2.20	1.70	7.0/4.0	1450	H07RN-F-6 G 1.5	H05VV-F-5 G 1.5	CEE-
compli ...25/4 BW1	D-Strom	3/N/PEp400	2.80	2.10	8.2/4.7	1450	H07RN-F-6 G 1.5	H05VV-F-5 G 1.5	CEE-
compli ...35/4 BW1	D-Strom	3/N/PEp400	4.20	3.20	13.0/7.8	1450	H07RN-F-6 G 1.5	H05VV-F-5 G 1.5	CEE-
compli ...25/2 BW1	D-Strom	3/N/PEp400	3.25	2.54	9.4/5.4	2900	H07RN-F-6 G 1.5	H05VV-F-5 G 1.5	CEE-
compli ...35/2 BW1	D-Strom	3/N/PEp400	4.20	3.43	12.6/7.3	2900	H07RN-F-6 G 1.5	H05VV-F-5 G 1.5	CEE-
compli ...15/4 CW1	D-Strom	3/N/PEp400	2.40	1.90	7.3/4.2	1450	H07RN-F-6 G 1.5	H05VV-F-5 G 1.5	CEE-
compli ...25/4 CW1	D-Strom	3/N/PEp400	2.70	2.04	7.9/4.6	1450	H07RN-F-6 G 1.5	H05VV-F-5 G 1.5	CEE-
compli ...35/4 CW1	D-Strom	3/N/PEp400	4.20	3.20	13.0/7.8	1450	H07RN-F-6 G 1.5	H05VV-F-5 G 1.5	CEE-

JUNG PUMPEN COMPLI 1200-1600

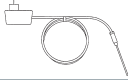
SEWAGE LIFTING STATIONS - STAINLESS STEEL

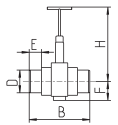
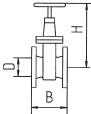
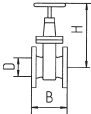
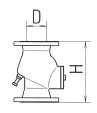
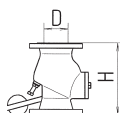
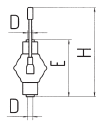
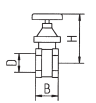
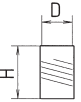
ACCESSORIES

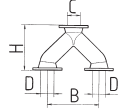
			Art.-Nr.										
	1	Seal leak detector DKG Please consider one seal leak detector per pump	JP44900										
	2	Rechargeable battery for control for mains-independent alarm	JP44850										
	3	PVC sluice valve (with two pipe sockets) for 6" inlet (DN 150) PN 2.5	JP28591										
		<table border="0"> <tr> <td>H</td> <td>B</td> <td>E</td> <td>F</td> <td>D</td> </tr> <tr> <td>660</td> <td>450</td> <td>110</td> <td>105</td> <td>160</td> </tr> </table>	H	B	E	F	D	660	450	110	105	160	
H	B	E	F	D									
660	450	110	105	160									
	4	Sluice valve* for 3" pressure side (DN 80), PN 10, DIN EN 1171	JP00639										
		<table border="0"> <tr> <td>H</td> <td>B</td> <td>D</td> </tr> <tr> <td>315</td> <td>180</td> <td>DN 80</td> </tr> </table>	H	B	D	315	180	DN 80					
H	B	D											
315	180	DN 80											
		Sluice valve* for 4" pressure side (DN 100), PN 10, DIN EN 1171	JP00329										
		<table border="0"> <tr> <td>H</td> <td>B</td> <td>D</td> </tr> <tr> <td>345</td> <td>190</td> <td>DN 100</td> </tr> </table>	H	B	D	345	190	DN 100					
H	B	D											
345	190	DN 100											
	5	Swing-type check valve* R 80, PN 4, flange PN 10, DIN 3202 DIN EN 12050-4 without counterweight	JP00706										
		<table border="0"> <tr> <td>H</td> <td>D/DN</td> </tr> <tr> <td>260</td> <td>80</td> </tr> </table>	H	D/DN	260	80							
H	D/DN												
260	80												
		Swing-type check valve* R 80 G PN 4, flange PN 10, DIN 3202 DIN EN 12050-4 with adjustable counterweight	JP00707										
		<table border="0"> <tr> <td>H</td> <td>D/DN</td> </tr> <tr> <td>260</td> <td>80</td> </tr> </table>	H	D/DN	260	80							
H	D/DN												
260	80												
		Ball-type check valve* K 80 PN 4, flange PN 10, DIN 3202 DIN EN 12050-4	JP44781										
		<table border="0"> <tr> <td>H</td> <td>D/DN</td> </tr> <tr> <td>260</td> <td>100</td> </tr> </table>	H	D/DN	260	100							
H	D/DN												
260	100												
		Swing-type check valve R 101* PN4, flange PN 10, DIN 3202 DIN EN 12050-4, without counterweight	JP00325										
		<table border="0"> <tr> <td>H</td> <td>D/DN</td> </tr> <tr> <td>300</td> <td>100</td> </tr> </table>	H	D/DN	300	100							
H	D/DN												
300	100												
		Swing-type check valve R 101 G PN4, flange PN 10, DIN 3202 DIN EN 12050-4, with adjustable counterweight	JP00324										
		<table border="0"> <tr> <td>H</td> <td>D/DN</td> </tr> <tr> <td>300</td> <td>100</td> </tr> </table>	H	D/DN	300	100							
H	D/DN												
300	100												
	6	Hand diaphragm pump for emergency purposes (bis H_{geod} 15 m)	JP00255										
		<table border="0"> <tr> <td>H</td> <td>E</td> <td>D</td> </tr> <tr> <td>ca. 640</td> <td>430</td> <td>1 1/2"</td> </tr> </table>	H	E	D	ca. 640	430	1 1/2"					
H	E	D											
ca. 640	430	1 1/2"											
	7	Stop valve, 1 1/2" (DN 40), PN 16	JP44786										
		<table border="0"> <tr> <td>H</td> <td>B</td> <td>D</td> </tr> <tr> <td>125</td> <td>max. 60</td> <td>1 1/2"</td> </tr> </table>	H	B	D	125	max. 60	1 1/2"					
H	B	D											
125	max. 60	1 1/2"											
	8	Elastic connection 1 1/2" (DN 40), PN 4	JP44777										
		<table border="0"> <tr> <td>H</td> <td>D</td> </tr> <tr> <td>120</td> <td>50</td> </tr> </table>	H	D	120	50							
H	D												
120	50												
	9	Clamp 1 1/2"	JP44763										
	10	Y-piece* DN 80/100/80	JP00202										
		<table border="0"> <tr> <td>H</td> <td>B</td> <td>C/DN</td> <td>D/DN</td> </tr> <tr> <td>355</td> <td>480</td> <td>100</td> <td>80</td> </tr> </table>	H	B	C/DN	D/DN	355	480	100	80			
H	B	C/DN	D/DN										
355	480	100	80										
		DN 100/100/100, PN 10	JP00203										
		<table border="0"> <tr> <td>H</td> <td>B</td> <td>C/DN</td> <td>D/DN</td> </tr> <tr> <td>355</td> <td>480</td> <td>100</td> <td>100</td> </tr> </table>	H	B	C/DN	D/DN	355	480	100	100			
H	B	C/DN	D/DN										
355	480	100	100										

* with screws and seal

JUNG PUMPEN COMPLI 1200-1600

SEWAGE LIFTING STATIONS - STAINLESS STEEL

TECHNISCHE DATEN

Pump

Vertical, single-stage, submersible, vortex impeller, spiral casing with vertical DN 100 (CW1) or rather DN 80 (BW1) outlet, flanged to stainless steel tank with cleaning opening.

Bearing

Common shaft for pump and motor, grease-packed ball bearing.

Seal

Silicon carbide mechanical seal independent of sense of rotation and safe to run dry. Oil chamber with duplex radial shaft seal as secondary seal towards the motor compartment. Connection possibility for seal leak detector.

Motor

Submersible, IP 68 type of protection, insulation class F, winding thermostats for the protection of the drives against

overheating, automatic start-up by rotary level control and contact. Connection to mains by 16 A CEE plug, S 3 type of operation in keeping with German standard VDE

Materials

Tank made of high-class, corrosion resistant stainless steel (1.4301, on request also 1.4571), pumps, motor housing and vortex impeller made of wear-resistant grey cast iron, rubber insulated cable.

Scope of supply

Ready to connect sewage lifting station in keeping with German / European standard DIN EN 12050-1 with clamp-type inlet DN 150, pre-mounted submersible pump and connecting flange, an elastic connection with clamps for plastic pressure pipe DN 100, collar DN 70 for ventilation and automatic rotary level

control. Control (IP 44 type of protection) with motor protection, contractor, transformer, mains-dependent alarm system and potential-free make contact for collective failure messages, with optical display of sense of rotation, alarm and operation, manual-0-automatic switch and automatic changeover system and peak load function.

To be fitted with a micro-processor control as well upon request.

Cable: Tank-control 10 m, control-plug 1,5 m

Accessories to be ordered according to mounting drawing.



Mounting arrangement

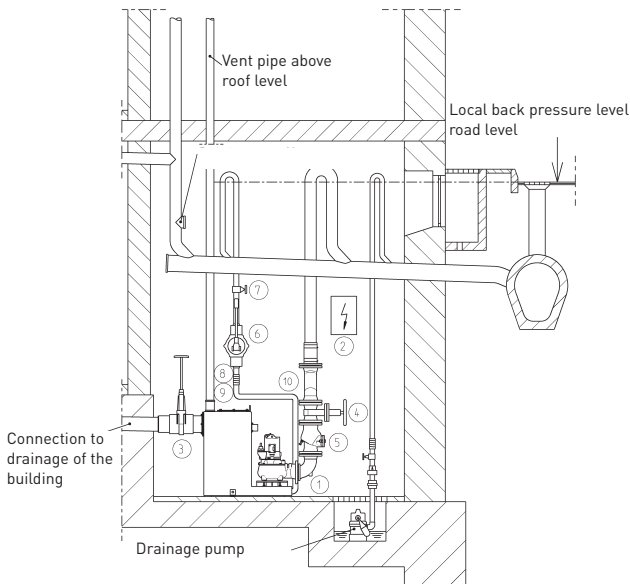

In keeping with the construction and testing principles of German / European standard DIN EN 12050, sewage disposal units are to be used for the transport of faecal matter and domestic waste-water in building drainage systems as described in German standard DIN 1983 T3. In keeping with the stipulations of German / European standard DIN EN 12056-4 they have to be mounted with collecting tanks inside building permitting a free space of 60 cm for operation and repair. The pressure pipe has to be passed above the locally defined backpressure level and a non-return valve tested in keeping with German / European standard 12050-4 has to be mounted. In keeping with German / European standard 12056 the ventilation pipe has to be passed up to the roof.

43240-00

Dimensions compli 1200 | 1400 | 1600 (mm)

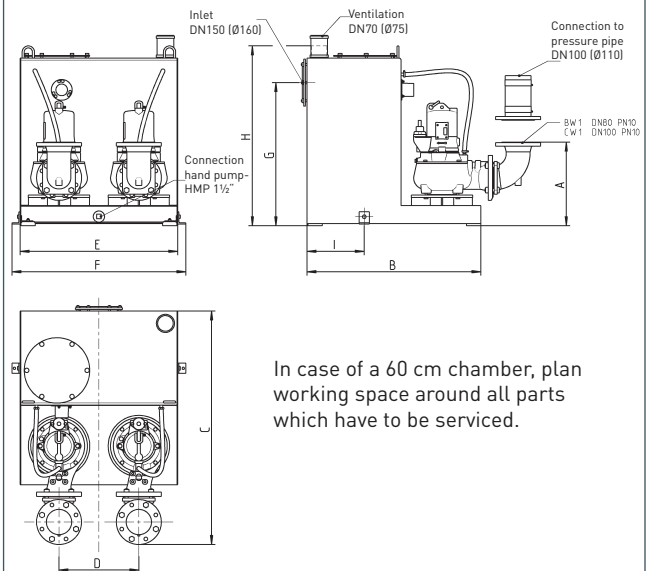

In case of a 60 cm chamber, plan working space around all parts which have to be serviced.

	A	B	C	D	E	F	G	H	I
compli 1200 CW1	410	850	1142	390	770	850	700	880	280
compli 1200 BW1	388	850	1097	390	770	850	700	880	280
compli 1400 CW1	455	1090	1375	480	970	1050	800	985	340
compli 1400 BW1	433	1090	1327	480	970	1050	800	985	340
compli 1600 CW1	455	1600	1882	480	970	1050	800	985	555
compli 1600 BW1	433	1600	1837	480	970	1050	800	985	555

4 43068-02